

8 7 6 5 4 3 2 1

F
E
D
C
B
A

PART NUMBER	<p>Top mounted = SQR-DROP-500-250H-30-E27 To suspend this shade we recomend buying a rod suspension kit SPK-ROD-E27-XXXX (where XXXX is replaced with the distance from ceiling to shade ring required) Bottom mounted = SQR-BASE-500-250H-30-E27 (shown)</p>
DESCRIPTION	Square Shade 500 Width & Depth by 250 High E27 BASE Mounted
LIGHT SOURCE	Not included with shade.
WIRING	<p>Top mounted = This shade has no electrical parts. Bottom mounted = The suspension kit recomend included an E27 lamp holder which will be wired through to the ceiling cup.</p>
SUSPENSION	<p>Top mounted = Shade is attached to E27 lamp holder (not included) with shade rings (not included). Bottom mounted = Recomend suspension kit includes lamp holder and shade tings and is attached to ceiling with ceiling cup and bracket.</p>
MATERIALS	Steel wire frame with fabric covered PVC panel.
WEIGHT (estimated)	0.65Kg (shade only)

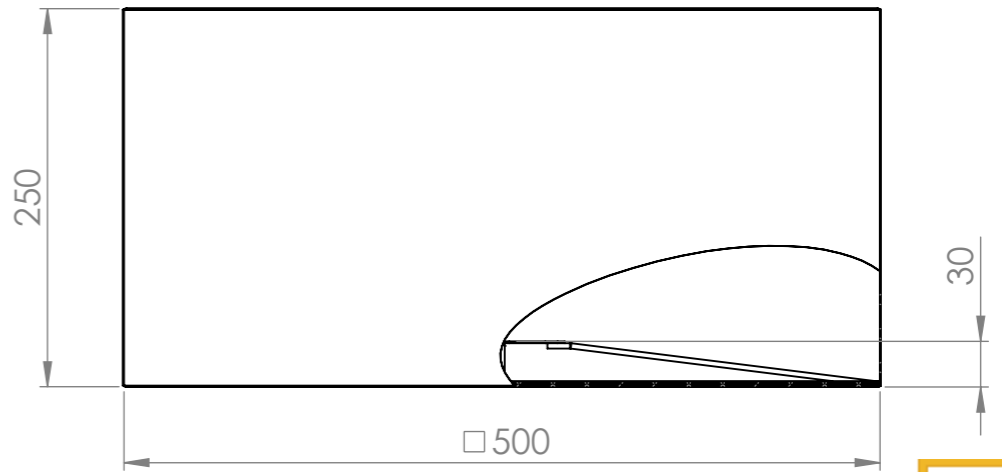
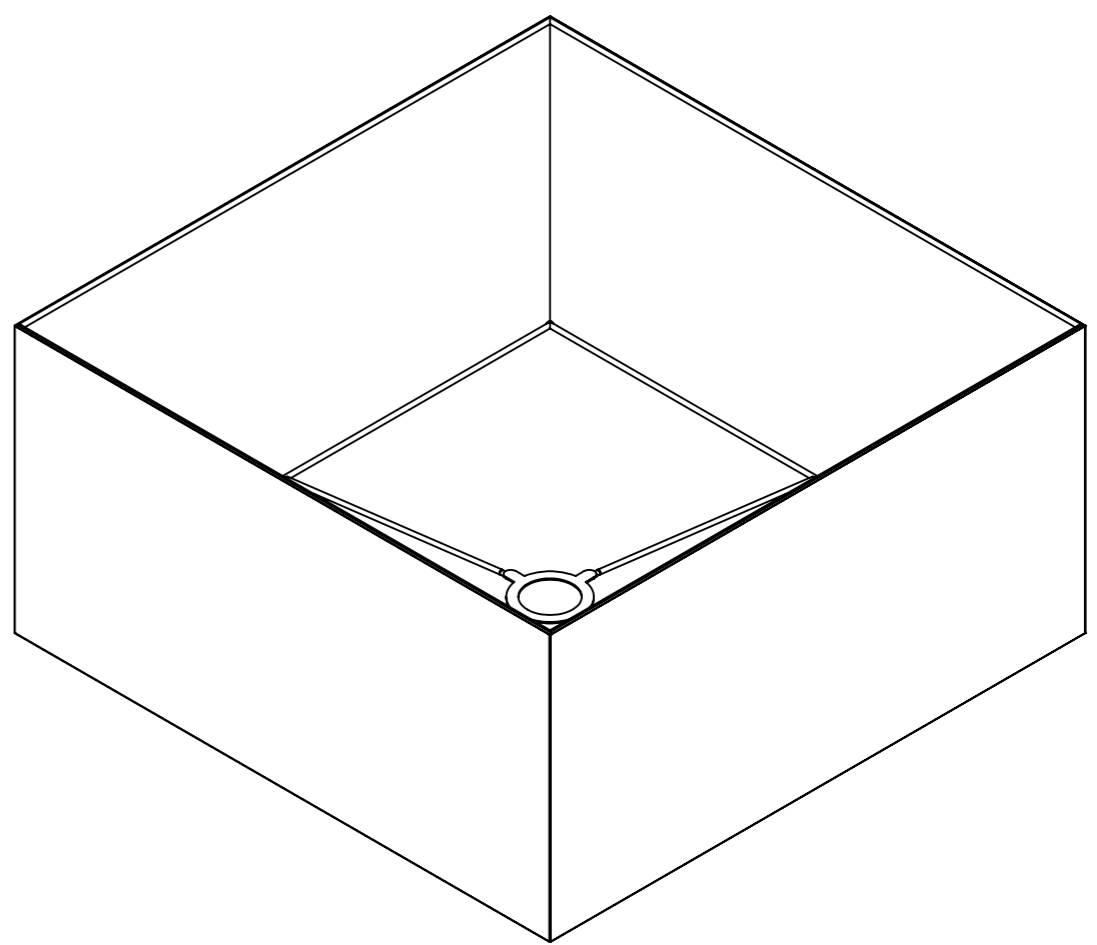

8 7 6 5 4 3 2 1

F
E
D
C
B
A