

8

7

6

5

4

3

2

1

F

E

D

C

B

A

F

E

D

C

B

A

PART NUMBER	OVAL-600-300-450H-45-E27
DESCRIPTION	Oval Shade 600 x 300 By 450mm High, E27
LIGHT SOURCE	Not included with shade.
WIRING	This shade has no electrical parts.
SUSPENSION	Shade is attached to E27 lamp holder (not included) with shade rings (not included).
MATERIALS	Steel wire frame with fabric covered PVC panel. Opal acrylic 030 diffuser option available.
WEIGHT (estimated)	1.24Kg

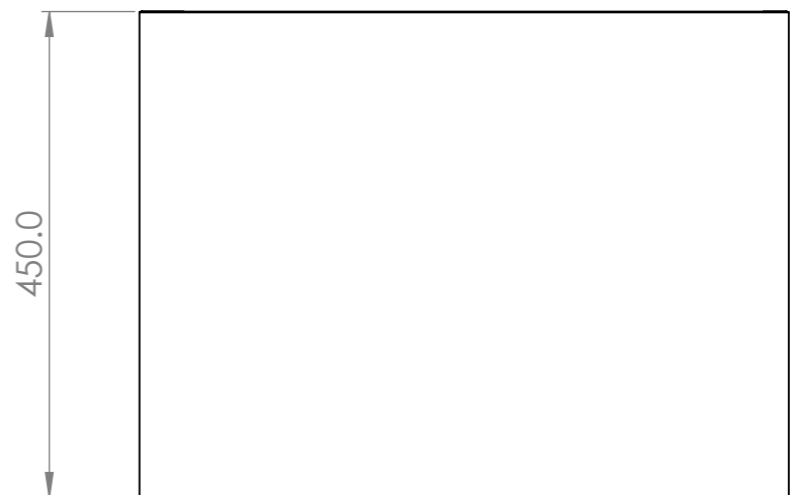
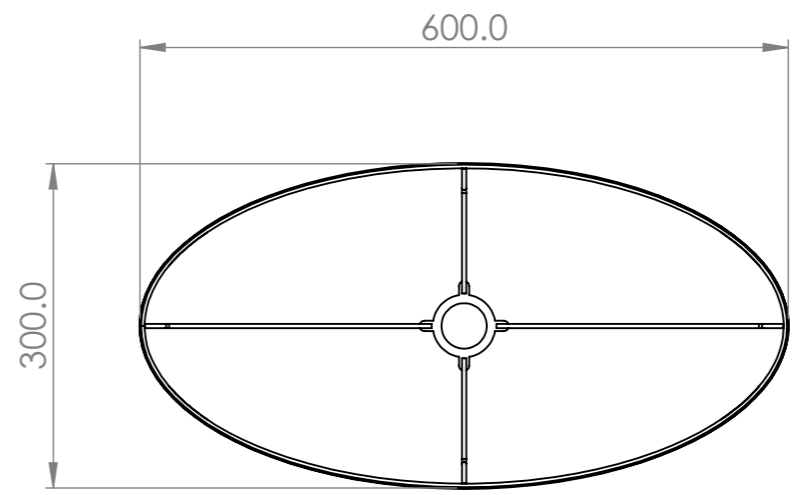
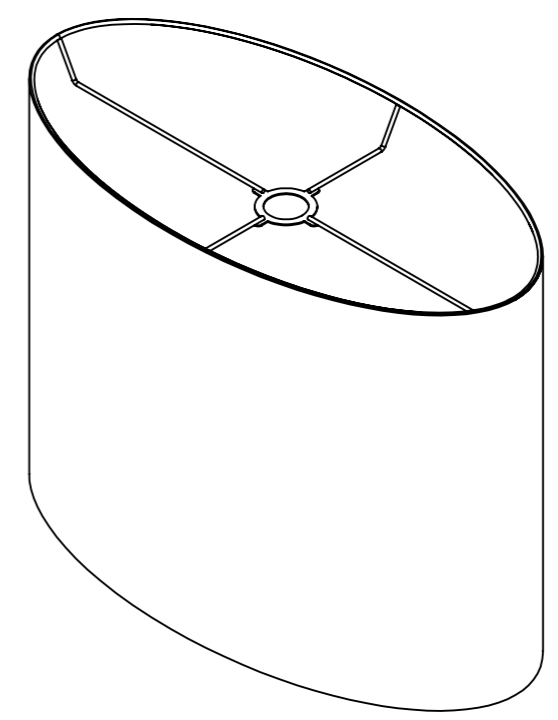

Iberian Lighting

8

7

6

5

4

3

2

1